

YOUNG 2.0 2GS CORNER ENTRY BI-FOLD



CORNER ENTRY, 2 HINGED FOLDING DOORS

TO COMPLETE A CORNER ENTRY, ORDER 2 SIDES (1 RIGHT SIDE + 1 LEFT SIDE)

Dimensions					Code	Left	Right	Glass			Profile type	
Size	Actual dimensions	Access	Projection			S-	D-	1	2	4	B	K
	A	*	B	B1				Clear	Aqua	Satin	Silver	Chrome
STANDARD												
70	67 ↔ 69	83	59	28,6	Y22GS67L	S-	D-	●				
76	73 ↔ 75	92	65	31,6	Y22GS73L	S-	D-	●				
80	77 ↔ 79	98	69	33,6	Y22GS77L	S-	D-	●				
90	87 ↔ 89	112	79	38,6	Y22GS87L	S-	D-	●				
100	97 ↔ 99	126	89	43,6	Y22GS97L	S-	D-	●				
120	117 ↔ 119	154	109	53,6	Y22GS117L	S-	D-	●				
OTHER SIZES												
◇	57 ↔ 59	69	49	23,6	Y22GS57L	S-	D-					
◇	59 ↔ 61	72	51	24,6	Y22GS59L	S-	D-					
◇	65 ↔ 67	81	57	27,6	Y22GS65L	S-	D-					
◇	69 ↔ 71	86	61	29,6	Y22GS69L	S-	D-	●				
◇	75 ↔ 77	95	67	32,6	Y22GS75L	S-	D-	●				
◇	79 ↔ 81	100	71	34,6	Y22GS79L	S-	D-	●				
◇	85 ↔ 87	109	77	37,6	Y22GS85L	S-	D-	●				
◇	89 ↔ 91	115	81	39,6	Y22GS89L	S-	D-	●				
◇	95 ↔ 97	123	87	42,6	Y22GS95L	S-	D-	●				
◇	99 ↔ 101	129	91	44,6	Y22GS99L	S-	D-	●				
◇	105 ↔ 107	141	97	47,6	Y22GS105L	S-	D-	●				
◇	115 ↔ 117	151	107	52,6	Y22GS115L	S-	D-	●				
◇	119 ↔ 121	157	111	54,6	Y22GS119L	S-	D-	●				

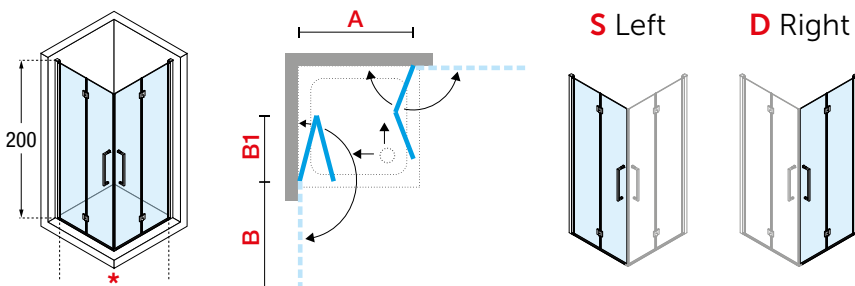

OPTIONAL



Easy hold replacement seal
Additional internal door hand-grip formed from clear plastic to replace original seal

Code

R50ABN2GS1-TR

● IN STOCK UK

(Other products) please check availability

See page 116 for the technical drawings of the Young 2.0 range

Construction of the Code: Code + Glass + Profile = Final product Code



OPTIONAL



Support bar

chrome finish

Dimensions	Code
15 cm	R80LOU150-K
25 cm	R80LOU250-K
35 cm	R80LOU350-K
45 cm	R80LOU450-K



Support bar 150 cm length

Profile	Code
Silver	R80Y215-B
Chrome	R80Y215-K



Adjustable bar kit

- 1 adjustable bar of 100 cm (shortened)
- wall attachment
- 1 glass clamp

Profile	Code
Silver	R80KUOR100-B
Chrome	R80KUOR100-K



"T" bar kit

support bar of 150 cm to match with the supplied bar for T solution

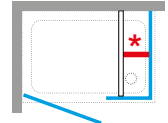

Profile	Code
Silver	R80Y215T-B
Chrome	R80Y215T-K



EVO fixing system

- 1 front bar of 180 cm
- 1 side bar of 120 cm
- 2 clamps
- 1 angular union

Profile	Code
Silver	KUADHSF-B
Chrome	KUADHSF-K



EVO fixing system (for recess version)

- 1 front bar of 180 cm
- 1 clamp

Profile	Code
Silver	KUADHSFN-B
Chrome	KUADHSFN-K

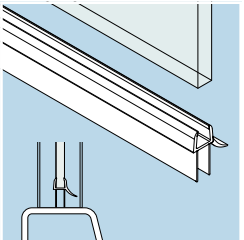

Deep seal when installed without the supplied threshold trim on a tiled or vinyl floor

Code
R51BOMO1-TR

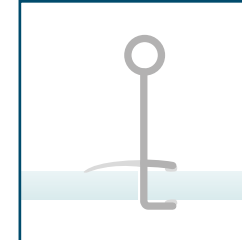

Easy hold replacement seal

Additional internal door hand-grip formed from clear plastic to replace original seal suitable for Young 1BS and 2GS models

Code
R50ABN2GS1-TR

TECHNICAL DATA

GLASS TYPES (European standards UNI EN 14428)



Clear
COD. 1



Aqua
COD. 2



Satin
COD. 4

HANDLES



Chromed metal handles

PROFILE COLOURS



Silver
COD. B



Chrome
COD. K

OVERALL DIMENSIONS FIXING PROFILES

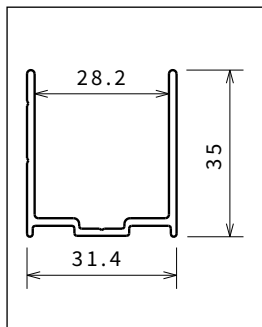

Standard profile

Height	Profile	Code
1984	Silver	P01BNMOBST-B
	Chrome	P01BNMOBST-K
2000	Silver	P01BNMOAST-B
	Chrome	P01BNMOAST-K

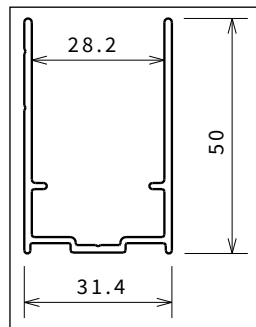

15mm + Extension profile

Height	Profile	Code
1984	Silver	P05Y2ST-B
	Chrome	P05Y2ST-K
2000	Silver	P05Y2ST2-B
	Chrome	P05Y2ST2-K

For more information about profiles, see page 260

HOW TO TAKE THE MEASUREMENTS

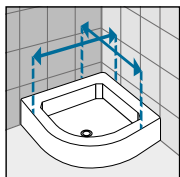
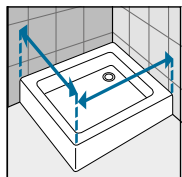

Take the measurements from wall to the external edge of the shower tray. Dimensions must be taken once the walls are finished and tiled, according to the above drawings.

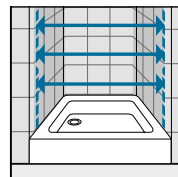

Take the measurements from wall to wall at the bottom, at the top, in the middle and use the smallest. Dimensions must be taken once the walls are finished and tiled, according to the above drawings.

TECHNICAL DRAWINGS

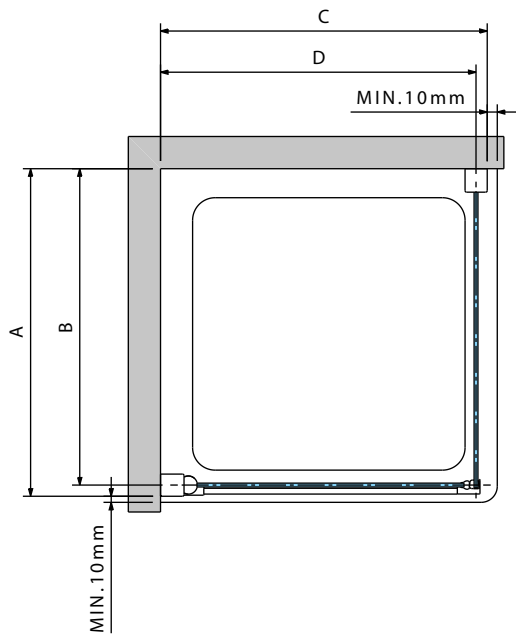

YOUNG 2.0 G+F

Code	C	D
Y2G57-	57-59	55,4-57,4
Y2G59-	59-61	57,4-59,4
Y2G61-	61-63	59,4-61,4
Y2G65-	65-67	63,4-65,4
Y2G67-	67-69	65,4-67,4
Y2G69-	69-71	67,4-69,4
Y2G72-	72-74	70,4-72,4
Y2G74-	74-76	72,4-74,4
Y2G77-	77-79	75,4-77,4
Y2G79-	79-81	77,4-79,4
Y2G85-	85-87	83,4-85,4
Y2G87-	87-89	85,4-87,4
Y2G89-	89-91	87,4-89,4
Y2G95-	95-97	93,4-95,4
Y2G97-	97-99	95,4-97,4
Y2G99-	99-101	97,4-99,4

YOUNG 2.0 F

Code	A	B
Y2FG57-	57-59	55,4-57,4
Y2FG59-	59-61	57,4-59,4
Y2FG61-	61-63	59,4-61,4
Y2FG65-	65-67	63,4-65,4
Y2FG67-	67-69	65,4-67,4
Y2FG69-	69-71	67,4-69,4
Y2FG73-	73-75	71,4-73,4
Y2FG75-	75-77	73,4-75,4
Y2FG77-	77-79	75,4-77,4
Y2FG79-	79-81	77,4-79,4
Y2FG85-	85-87	83,4-85,4
Y2FG87-	87-89	85,4-87,4
Y2FG89-	89-91	87,4-89,4
Y2FG95-	95-97	93,4-95,4
Y2FG97-	97-99	95,4-97,4
Y2FG99-	99-101	97,4-99,4
Y2FG117-	117-119	115,4-117,4
Y2FG119-	119-121	117,4-119,4

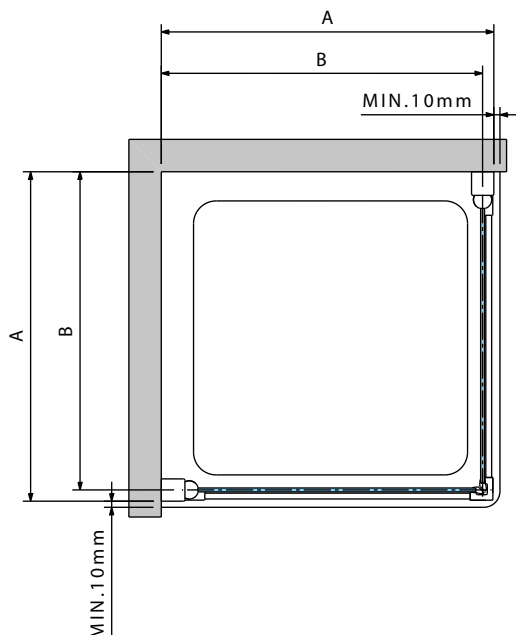

YOUNG 2.0 2G

Code	C	D
Y22G57	57-59	55,4-57,4
Y22G59	59-61	57,4-59,4
Y22G61	61-63	59,4-61,4
Y22G65	65-67	63,4-65,4
Y22G67	67-69	65,4-67,4
Y22G69	69-71	67,4-69,4
Y22G72	72-74	70,4-72,4
Y22G74	74-76	72,4-74,4
Y22G77	77-79	75,4-77,4
Y22G79	79-81	77,4-79,4
Y22G85	85-87	83,4-85,4
Y22G87	87-89	85,4-87,4
Y22G89	89-91	87,4-89,4
Y22G95	95-97	93,4-95,4
Y22G97	97-99	95,4-97,4
Y22G99	99-101	97,4-99,4

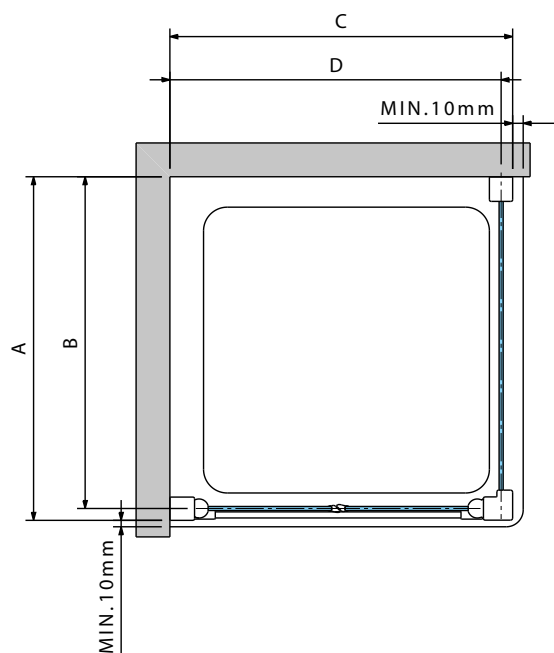

YOUNG 2.0 2B+F2B

Code	C	D
Y22B57-	58-62	56,6-60,4
Y22B63-	64-68	62,6-66,4
Y22B67-	68-72	66,6-70,4
Y22B71-	72-76	70,6-74,4
Y22B73-	74-78	72,6-76,4
Y22B77-	78-82	76,6-80,4
Y22B83-	84-88	82,6-86,4
Y22B87-	91-95	86,6-90,4
Y22B93-	94-98	92,6-96,4
Y22B97-	98-102	96,6-100,4
Y22B103-	104-108	102,6-106,4
Y22B107-	108-112	106,6-110,4
Y22B113-	114-118	112,6-116,4
Y22B117-	118-122	116,6-120,4
Y22B137-	138-142	136,6-140,4
Y22B147-	148-152	146,6-150,4
Y22B157-	158-162	156,6-160,4
Y22B167-	168-172	166,6-170,4
Y22B177-	178-182	176,6-180,4

YOUNG 2.0 F2B

Code	C	D
Y2F2B57-	57-59	55,4-57,4
Y2F2B59-	59-61	57,4-59,4
Y2F2B65-	56-58	54,4-56,4
Y2F2B67-	67-69	65,4-67,4
Y2F2B69-	82-86	67,4-69,4
Y2F2B73-	73-75	71,4-73,4
Y2F2B75-	92-96	73,4-75,4
Y2F2B77-	77-79	75,4-77,4
Y2F2B79-	79-81	77,4-79,4
Y2F2B85-	85-87	83,4-85,4
Y2F2B87-	87-89	85,4-87,4
Y2F2B89-	89-91	87,4-89,4
Y2F2B95-	95-97	93,4-95,4
Y2F2B97-	97-99	95,4-97,4
Y2F2B99-	99-101	97,4-99,4
Y2F2B117-	117-119	115,4-117,4
Y2F2B119-	119-121	117,4-119,4

TECHNICAL DRAWINGS

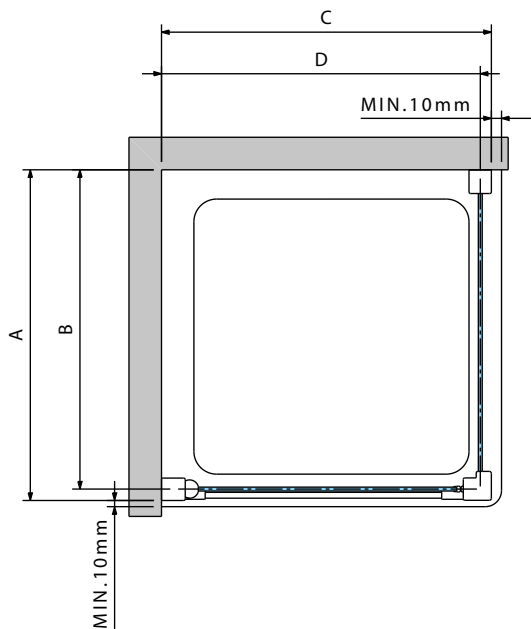

YOUNG 2.0 1B+F1B

Code	C	D
Y21B57-	58-62	56,4-60,4
Y21B67-	68-72	66,4-70,4
Y21B72-	73-77	71,4-75,4
Y21B77-	78-82	76,4-80,4
Y21B82-	83-87	81,4-85,4
Y21B87-	88-92	86,4-90,4
Y21B92-	93-97	91,4-95,4
Y21B97-	98-102	96,4-100,4

YOUNG 2.0 F1B

Code	A	B
Y2F1B57-	57-59	55,4-57,4
Y2F1B59-	59-61	57,4-59,4
Y2F1B65-	65-67	63,4-65,4
Y2F1B67-	67-69	65,4-67,4
Y2F1B69-	69-71	67,4-69,4
Y2F1B73-	73-75	71,4-73,4
Y2F1B75-	75-77	73,4-75,4
Y2F1B77-	77-79	75,4-77,4
Y2F1B79-	79-81	77,4-79,4
Y2F1B85-	85-87	83,4-85,4
Y2F1B87-	87-89	85,4-87,4
Y2F1B89-	89-91	87,4-89,4
Y2F1B95-	95-97	93,4-95,4
Y2F1B97-	97-99	95,4-97,4
Y2F1B99-	99-101	97,4-99,4
Y2F1B117-	117-119	115,4-117,4
Y2F1B119-	119-121	117,4-119,4

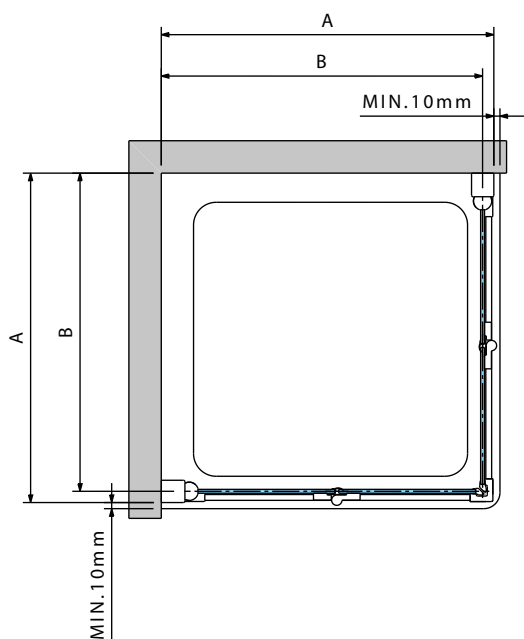

YOUNG 2.0 2GS

Code	A	B
Y22GS57L	57-59	55,4-57,4
Y22GS59L	59-61	57,4-59,4
Y22GS65L	65-67	63,4-65,4
Y22GS67L	67-69	65,4-67,4
Y22GS69L	69-71	67,4-69,4
Y22GS73L	73-75	71,4-73,4
Y22GS75L	75-77	73,4-75,4
Y22GS77L	77-79	75,4-77,4
Y22GS79L	79-81	77,4-79,4
Y22GS85L	85-87	83,4-85,4
Y22GS87L	87-89	85,4-87,4
Y22GS89L	89-91	87,4-89,4
Y22GS95L	95-97	93,4-95,4
Y22GS97L	97-99	95,4-97,4
Y22GS99L	99-101	97,4-99,4
Y22GS105L	105-107	103,4-105,4
Y22GS115L	115-117	113,4-115,4
Y22GS117L	117-119	115,4-117,4
Y22GS119L	119-121	117,4-119,4

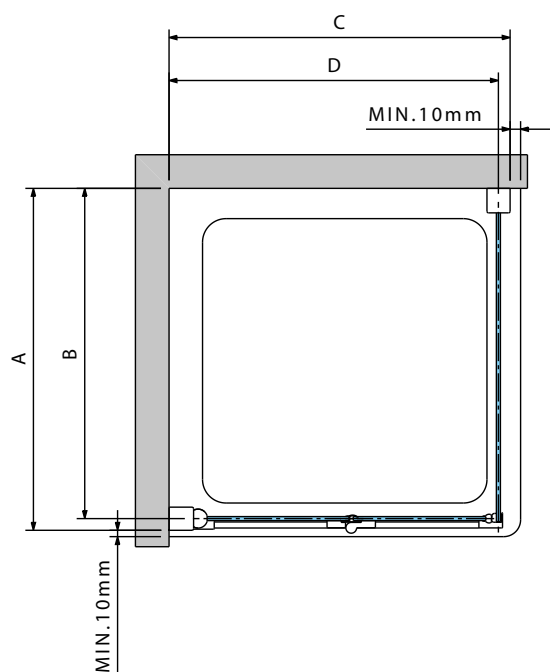

YOUNG 2.0 2GS+F

Code	C	D
Y22GS57L	58-60	56,4-58,4
Y22GS59L	60-62	58,4-60,4
Y22GS65L	66-68	64,4-66,4
Y22GS67L	68-70	66,4-68,4
Y22GS69L	70-72	68,4-70,4
Y22GS73L	74-76	72,4-74,4
Y22GS75L	76-78	74,4-76,4
Y22GS77L	78-80	76,4-78,4
Y22GS79L	80-82	78,4-80,4
Y22GS85L	86-88	84,4-86,4
Y22GS87L	88-90	86,4-88,4
Y22GS89L	90-92	88,4-90,4
Y22GS95L	96-98	94,4-96,4
Y22GS97L	98-100	96,4-98,4
Y22GS99L	100-102	98,4-100,4
Y22GS105L	106-108	104,4-106,4
Y22GS115L	116-118	114,4-116,4
Y22GS117L	118-120	116,4-118,4
Y22GS119L	120-122	118,4-120,4

YOUNG 2.0 F

Code	A	B
Y2FG57-	57-59	55,4-57,4
Y2FG59-	59-61	57,4-59,4
Y2FG61-	61-63	59,4-61,4
Y2FG65-	65-67	63,4-65,4
Y2FG67-	67-69	65,4-67,4
Y2FG69-	69-71	67,4-69,4
Y2FG73-	73-75	71,4-73,4
Y2FG75-	75-77	73,4-75,4
Y2FG77-	77-79	75,4-77,4
Y2FG79-	79-81	77,4-79,4
Y2FG85-	85-87	83,4-85,4
Y2FG87-	87-89	85,4-87,4
Y2FG89-	89-91	87,4-89,4
Y2FG95-	95-97	93,4-95,4
Y2FG97-	97-99	95,4-97,4
Y2FG99-	99-101	97,4-99,4
Y2FG117-	117-119	115,4-117,4
Y2FG119-	119-121	117,4-119,4

TECHNICAL DRAWINGS

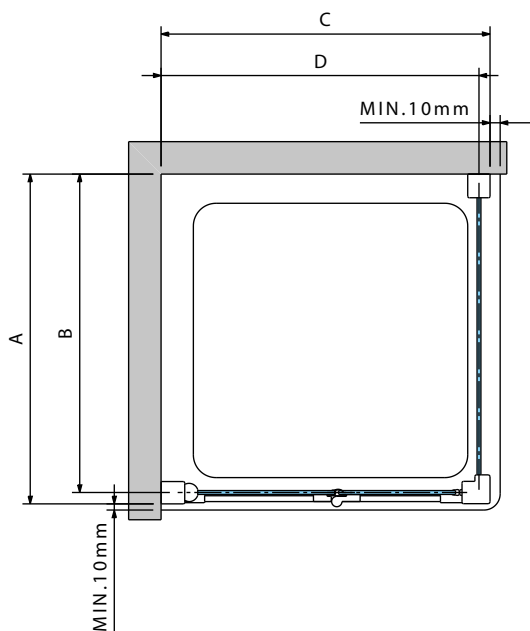

YOUNG 2.0 1BS+F1B

Code	C	D
Y21BS57	58-62	56,4-60,4
Y21BS67	68-72	66,4-70,4
Y21BS72	73-77	71,4-75,4
Y21BS77	78-82	76,4-80,4
Y21BS82	83-87	81,4-85,4
Y21BS87	88-92	86,4-90,4
Y21BS94	95-99	93,4-97,4
Y21BS97	98-102	96,4-100,4
Y21BS107	107-112	106,4-110,4
Y21BS117	118-122	116,4-120,4

YOUNG 2.0 F1B

Code	A	B
Y2F1B57-	57-59	55,4-57,4
Y2F1B59-	59-61	57,4-59,4
Y2F1B65-	65-67	63,4-65,4
Y2F1B67-	67-69	65,4-67,4
Y2F1B69-	69-71	67,4-69,4
Y2F1B73-	73-75	71,4-73,4
Y2F1B75-	75-77	73,4-75,4
Y2F1B77-	77-79	75,4-77,4
Y2F1B79-	79-81	77,4-79,4
Y2F1B85-	85-87	83,4-85,4
Y2F1B87-	87-89	85,4-87,4
Y2F1B89-	89-91	87,4-89,4
Y2F1B95-	95-97	93,4-95,4
Y2F1B97-	97-99	95,4-97,4
Y2F1B99-	99-101	97,4-99,4
Y2F1B117-	117-119	115,4-117,4
Y2F1B119-	119-121	117,4-119,4

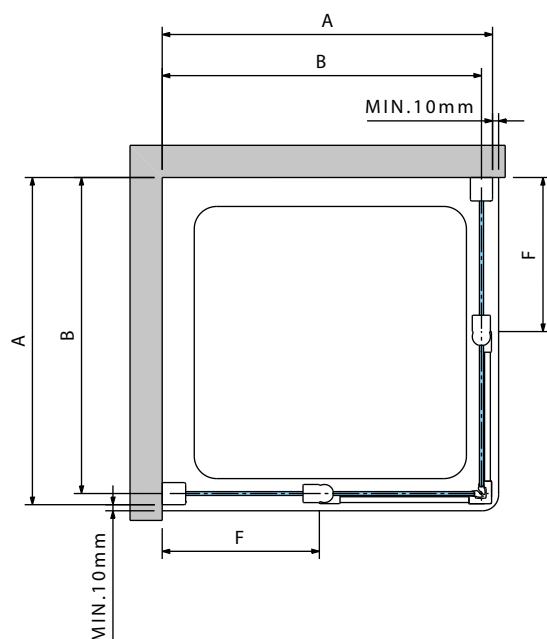

YOUNG 2.0 A

Code	F	A	B
Y2A57L-	27	57-59	55,4-57,4
Y2A59L-	27	59-61	57,4-59,4
Y2A61L-	27	61-63	59,4-61,4
Y2A65L-	27	65-67	63,4-65,4
Y2A67L-	27	67-69	65,4-67,4
Y2A69L-	27	69-71	67,4-69,4
Y2A73L-	35	73-75	71,4-73,4
Y2A75L-	35	75-77	73,4-75,4
Y2A77L-	35	77-79	75,4-77,4
Y2A79L-	35	79-81	77,4-79,4
Y2A85L-	43	85-87	83,4-85,4
Y2A87L-	43	87-89	85,4-87,4
Y2A89L-	43	89-91	87,4-89,4
Y2A95L-	43	95-97	93,4-95,4
Y2A97L-	43	97-99	95,4-97,4
Y2A99L-	43	99-101	97,4-99,4

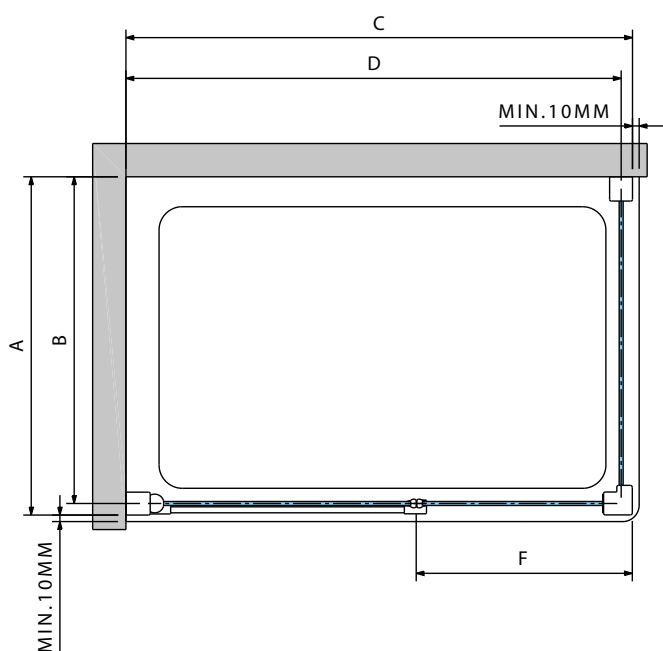

YOUNG 2.0 GFL+F1B

Code	F	C	D
Y2GFL97	32,5	98-102	96,4-100,4
Y2GFL107	42,5	108-112	106,4-110,4
Y2GFL114	39,5	115-119	113,4-117,4
Y2GFL117	42,5	118-122	116,4-120,4
Y2GFL134	49,5	135-139	133,4-137,4
Y2GFL137	52,5	138-142	136,4-140,4
Y2GFL147	52,5	148-153	146,4-150,4
Y2GFL154	59,5	155-159	153,4-157,4
Y2GFL157	62,5	158-162	156,4-160,4
Y2GFL164	69,5	165-169	163,4-167,4
Y2GFL167	72,5	168-172	166,4-170,4
Y2GFL177	82,5	178-182	176,4-180,4

YOUNG 2.0 F1B

Code	A	B
Y2F1B57-	57-59	55,4-57,4
Y2F1B59-	59-61	57,4-59,4
Y2F1B65-	65-67	63,4-65,4
Y2F1B67-	67-69	65,4-67,4
Y2F1B69-	69-71	67,4-69,4
Y2F1B73-	73-75	71,4-73,4
Y2F1B75-	75-77	73,4-75,4
Y2F1B77-	77-79	75,4-77,4
Y2F1B79-	79-81	77,4-79,4
Y2F1B85-	85-87	83,4-85,4
Y2F1B87-	87-89	85,4-87,4
Y2F1B89-	89-91	87,4-89,4
Y2F1B95-	95-97	93,4-95,4
Y2F1B97-	97-99	95,4-97,4
Y2F1B99-	99-101	97,4-99,4
Y2F1B117-	117-119	115,4-117,4
Y2F1B119-	119-121	117,4-119,4